

RUSTIC FIRE CLAY CERAMIC INSET SINK CRT10101WH/

RANGEmaster
sinks & taps



Size: 1000 x 500 mm

Offering a modern, farmhouse feel, Rustic kitchen sinks are designed to cater the needs of an enthusiastic chef.

- Reversible drainer
- Waste kit included
- 10 year warranty

Material	Fire clay Ceramic
Material Gauge	-
Material Finish Bowl	-
Material Finish Drainer	-
Drainer Position	Reversible
Overall Length (mm)	1000
Overall Width (mm)	500
Main Bowl Length (mm)	460
Main Bowl Width (mm)	390
Main Bowl Depth (mm)	195
Second Bowl Length (mm)	-
Second Bowl Width (mm)	-
Second Bowl Depth (mm)	-
Tap hole Size (mm)	-
Waste Size (mm)	1 x 90
Waste Kit	Included with sink (1 x 90mm BSW & overflow kit)
Min. Base Unit (mm)	600
Cutout Size Length (mm)	980
Cutout Size Width (mm)	480
Warranty Sinks (years)	10
Product Code	CRT10101WH/
Barcode	5015834049250

Date of download: July 28, 2022

AGA Rangemaster continuously seeks improvements in specification, design and production of products and thus, alterations take place periodically. Whilst every effort is made to produce up-to date resources, the information included here is intended as a guide. Always refer to the product's installation instructions when fitting, installation work should be completed a professional tradesman.

RUSTIC FIRE CLAY CERAMIC INSET SINK

CRT10101WH/

Technical Drawing

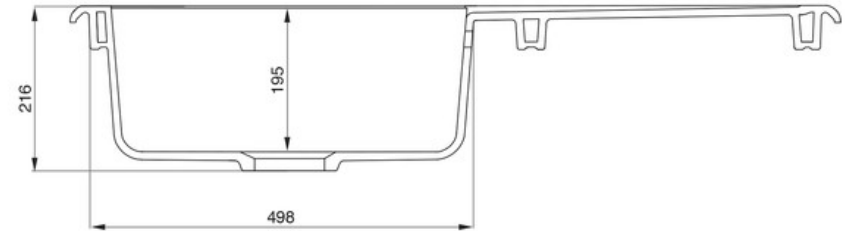
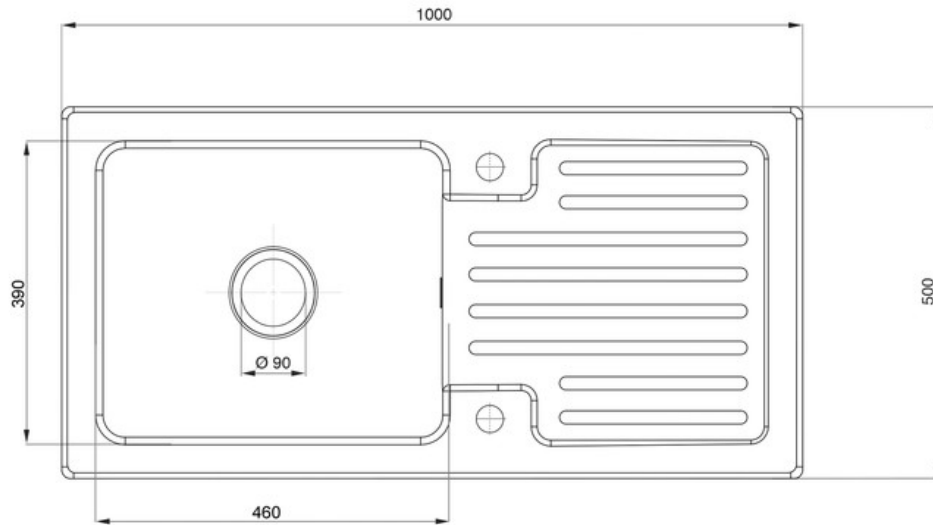

NB: Due to manufacturing processes this sink may have a +/- 3mm tolerance on the measurements.

Date of download: July 28, 2022

AGA Rangemaster continuously seeks improvements in specification, design and production of products and thus, alterations take place periodically. Whilst every effort is made to produce up-to date resources, the information included here is intended as a guide. Always refer to the product's installation instructions when fitting, installation work should be completed a professional tradesman.

RUSTIC FIRE CLAY CERAMIC INSET SINK

CRT10101WH/

Cut Out Template
Dimensions in mm. Not to scale.

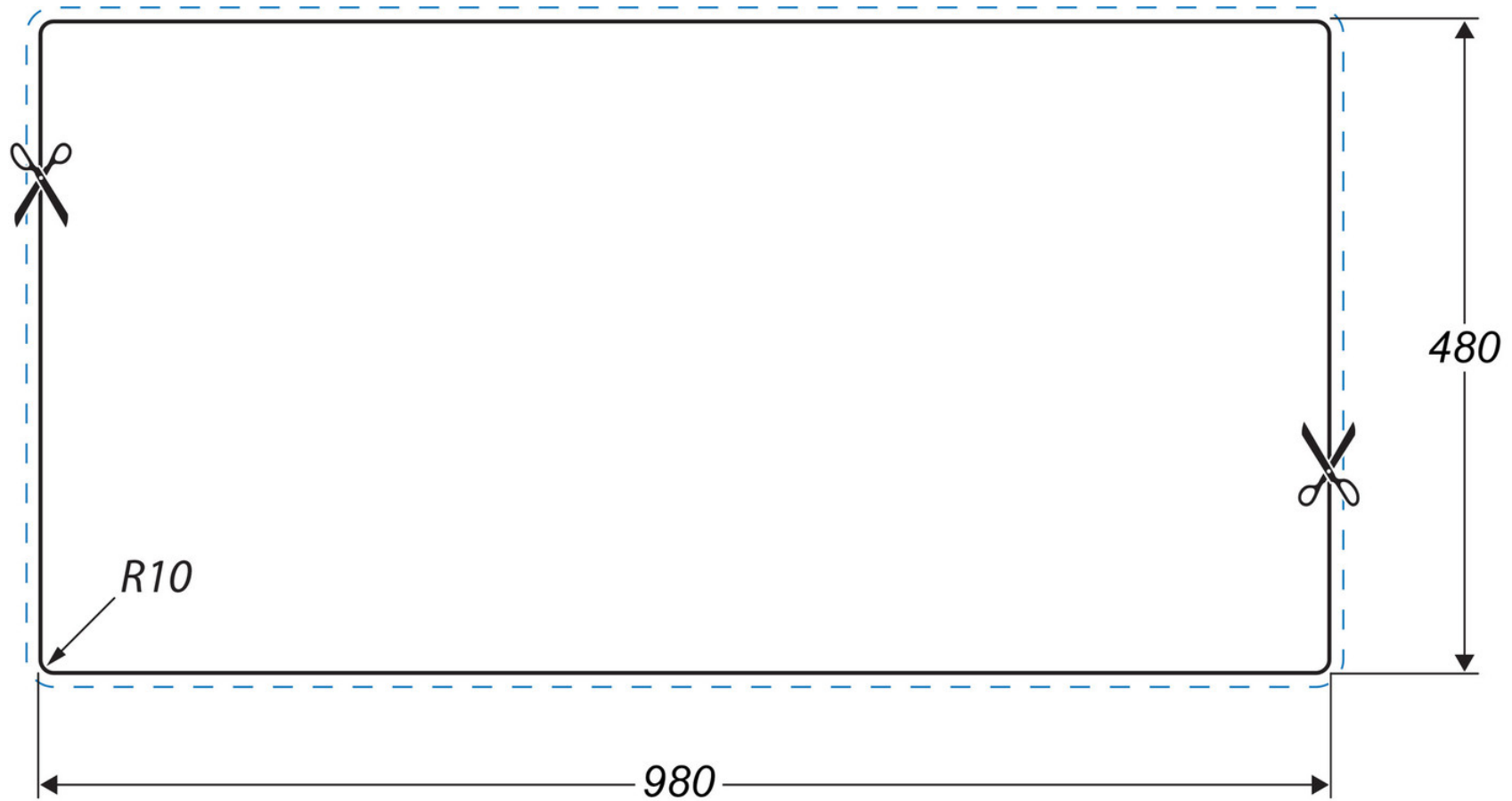

Date of download: July 28, 2022

AGA Rangemaster continuously seeks improvements in specification, design and production of products and thus, alterations take place periodically. Whilst every effort is made to produce up-to date resources, the information included here is intended as a guide. Always refer to the product's installation instructions when fitting, installation work should be completed a professional tradesman.